

WIRE TABLE Ø30
Assembly Instruction



Before you get started



Read the entire manual
before mounting

Recommendation: If the external flexible cable or cord of this luminaire is damaged, it shall be exclusively replaced by the manufacturer or their service agent or a similar qualified person in order to avoid a hazard.

Maintenance: IMPORTANT! Clean with a soft cloth, warm water and a mild detergent. Do NOT use any abrasive materials.

Light source: To achieve a bright, warm and clean light we recommend a light source with the following: 800+ lumens, 2700 Kelvin, CRI90+

Box contains:

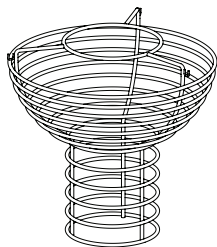

Wire Base x 1

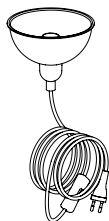

Cup x 1

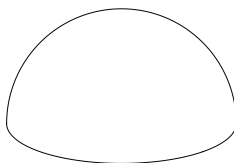

Shell x 1

You will also need:



E14, max. 60W

1

Pull the cord down through the center of the lamp and out over the bottom ring. Insert light source. Attach the acrylic shell on top of the lamp.

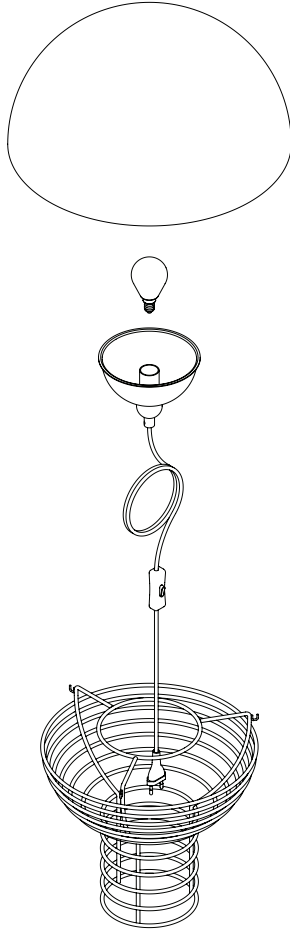

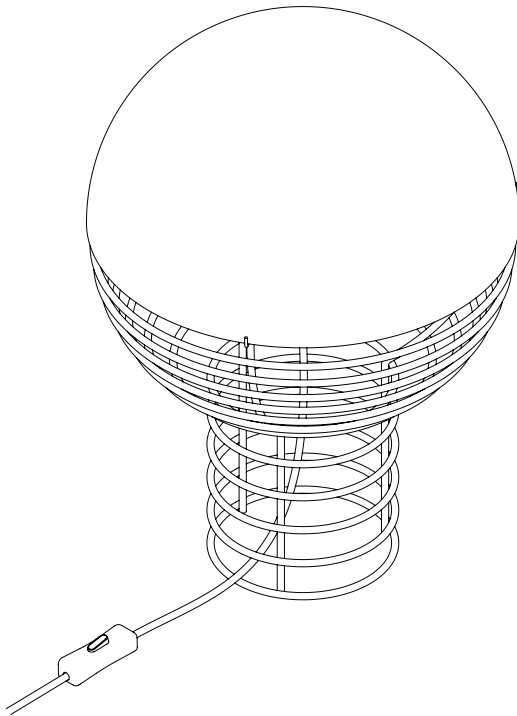



Egeskovvej 29 | 8700 Horsens | Denmark
info@verpan.com | verpan.com