

GHOST PENDANT

**SMALL
ASSEMBLY INSTRUCTION**

W0UD

INSTRUCTION MANUAL

**PLEASE GO THROUGH THE FOLLOWING
STEPS CAREFULLY. RETAIN THIS MANUAL
FOR FUTURE REFERENCE TO ENSURE THAT
YOUR NEW ITEM IS CORRECTLY ASSEMBLED
IN CASE IT SHOULD BE DISASSEMBLED OR
MOVED. WE ARE NOT RESPONSIBLE FOR
ANY FAULTS OR DAMAGES CAUSED BY
NOT FOLLOWING THESE INSTRUCTIONS
CORRECTLY.**

STEP 1

DECIDE THE LENGTH OF THE CORD AND MOUNT THE CEILING ROSE BRACKET USING THE WALL PLUGS AND SCREWS.

EU / SAA

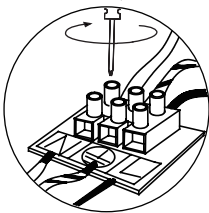
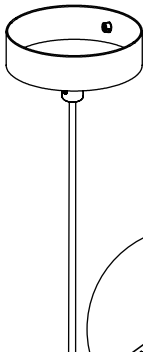
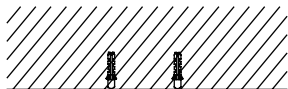

cUL

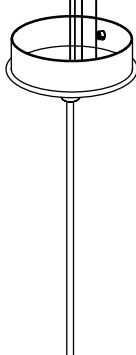
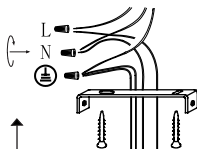
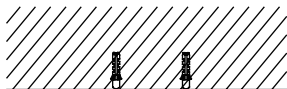

STEP 2

MOUNT THE CEILING ROSE TO THE BRACKET USING THE SMALL SCREW BOLTS. THEN INSERT A SUITABLE LIGHT BULB.

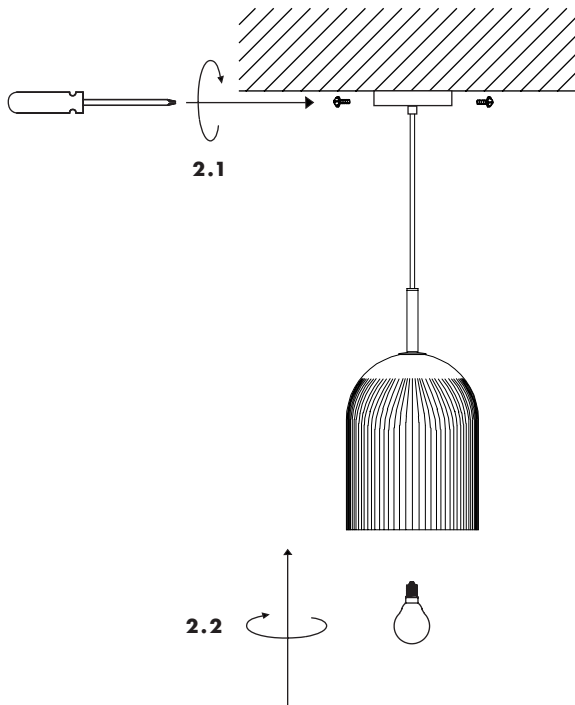

SAFETY INSTRUCTIONS



IF THE EXTERNAL FLEXIBLE CABLE OR CORD OF THIS LUMINAIRE IS DAMAGED, IT SHALL BE EXCLUSIVELY REPLACED BY THE MANUFACTURER OR SIMILAR QUALIFIED PERSON IN ORDER TO AVOID A HAZARD.

THE LAMP IS ONLY INTENDED FOR INTERIOR USE.
LAMP EXTERIOR CAN GET HOT AFTER PROLONGED USE.

ENSURE BULB HAS FULLY COOLED BEFORE
ATTEMPTING TO REMOVE IT.

PROTECT FROM CONTACT WITH LIQUIDS.
DO NOT PLACE THE CABLE IN REACH OF SMALL
CHILDREN OR ANYWHERE THERE IS A RISK OF
FALLING OVER IT.

WARNING: MUST BE INSTALLED BY
A LICENCED ELECTRICIAN.

SAFETY PRECAUTIONS

DK - SIKKERHEDSFORANSTALTNINGER DEN GRØNNE OG GULE LEDNING MÅ KUN VÆRE FORBUNDET TIL DEN INDGANGEN MARKERET MED ⊕ eller ⊚. HVIS LAMPENS UDVENDIGE LEDNING BLIVER BESKADIGET SKAL DER, FOR AT UNDGÅ EN FARLIG SITUATION, RETTES HENVENDELSE TIL PRODUCENTEN, SERVICE AGENTEN ELLER ANDEN LIGNENDE KVALIFICERET PERSON FOR UDSKIFTNING AF DENNE.

UK - SAFETY PRECAUTIONS THE CORE WITH GREEN/YELLOW INSULATION MUST ONLY BE CONNECTED TO A TERMINAL MARKED WITH ⊕ OR ⊚. IF THE EXTERNAL FLEXIBLE CABLE OR CORD OF THIS LUMINAIRE IS DAMAGED, IT SHALL BE EXCLUSIVELY REPLACED BY THE MANUFACTURER OR HIS SERVICE AGENT OR A SIMILAR QUALIFIED PERSON IN ORDER TO AVOID A HAZARD.

F - PRÉCAUTIONS DE SÉCURITÉ LE CÂBLE VERT ET JAUNE DOIT ÊTRE CONNECTÉ UNIQUEMENT À UNE BORNE MARQUÉE PAR ⊕ OU ⊚. SI LE CÂBLE FLEXIBLE EXTERNE OU LE CORDON DE CE LUMINAIRE EST ENDOMMAGÉ, IL DOIT ÊTRE EXCLUSIVEMENT REMPLACÉ PAR LE FABRICANT, SON AGENT DE SERVICE OU UNE PERSONNE QUALIFIÉE SIMILAIRE AFIN D'ÉVITER TOUT DANGER.

E - MEDIDAS DE SEGURIDAD EL CABLE VERDE/AMARILLO SOLE DEBE CONECTARSE A UN TERMINAL MARCADO SON ⊕ O ⊚. SI EL CABLE EXTERNO O CORDÓN DE ESTA LUMINARIA ES DAÑADO, DEBERÁ SER REEMPLAZADO EXCLUSIVAMENTE POR EL FABRICANTE, SU AGENTE COMERCIAL O PERSONA CUALIFICADA SIMILAR PARA EVITAR CUALQUIER PELIGRO.

D - SICHERHEITSVORKEHRUNGEN DIE GRÜN/GELB ISOLIERTE ADER DARF NUR AN EINE KLEMME ANGESCHLOSSEN WERDEN, DIE WIE FOLGT GEKENNZEICHNET IST ⊕ ODER ⊚. WENN DAS ÄUSSERE FLEXIBLE KABEL ODER DIE SCHNUR DIESER LEUCHE BESCHÄDIGT IST, DARF NUR DER HERSTELLER ODER SEIN KUNDENDIENST ODER EINE ÄHNLICH QUALIFIZIERTE PERSON DAS KABEL ERSETZEN, UM EINE GEFÄHRDUNG ZU VERMEIDEN.

DESIGNED BY
STUDIO KOWALEWSKI